

## Legnaia singola a 2 falde SCHEMA TIPO Scala 1:50

NOTA BENE: VALE COMUNQUE  
IL LIMITE DI 60 MC STABILITO  
DALLE NORME DI ATTUAZIONE

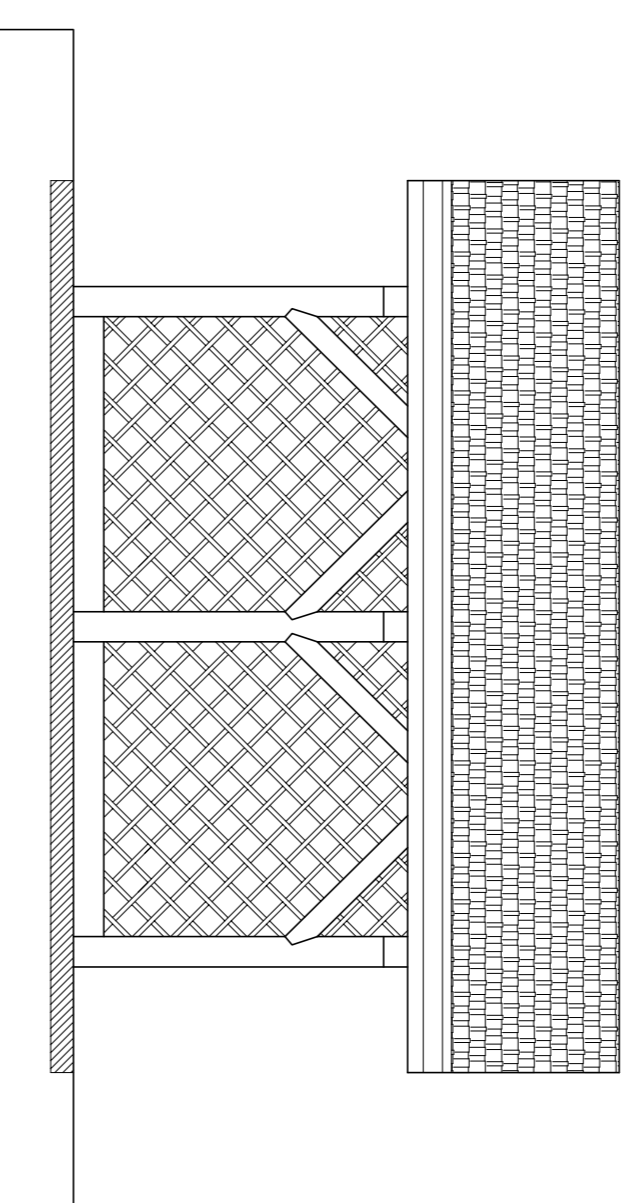
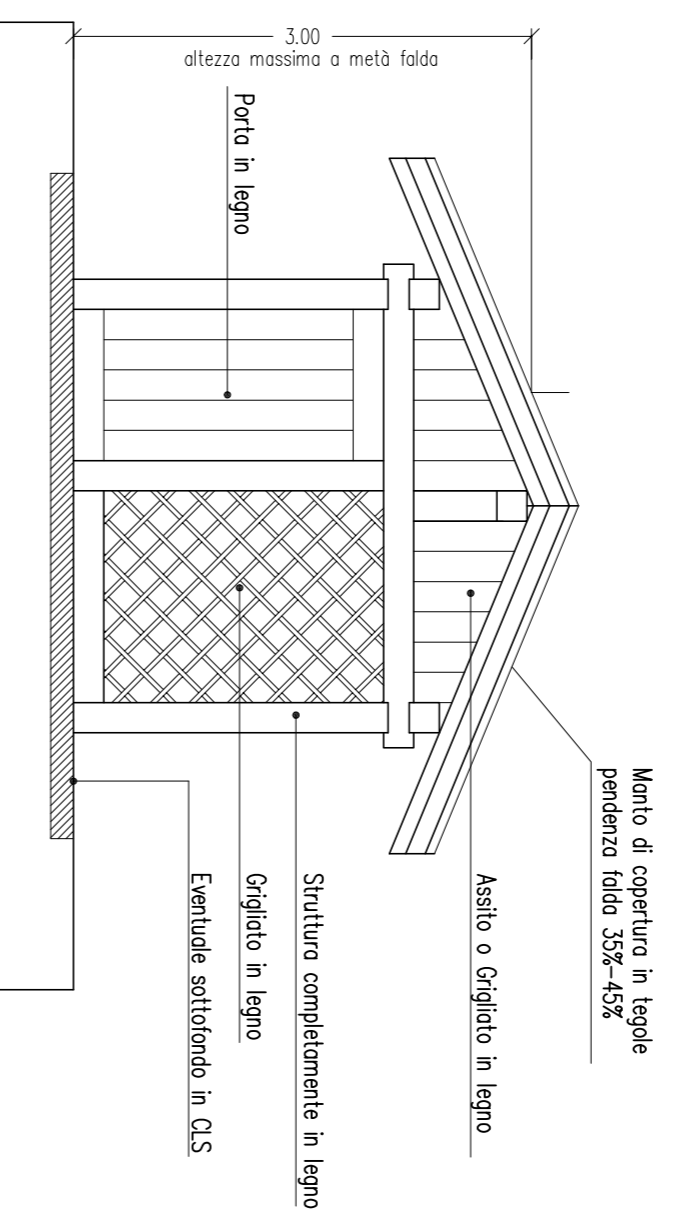
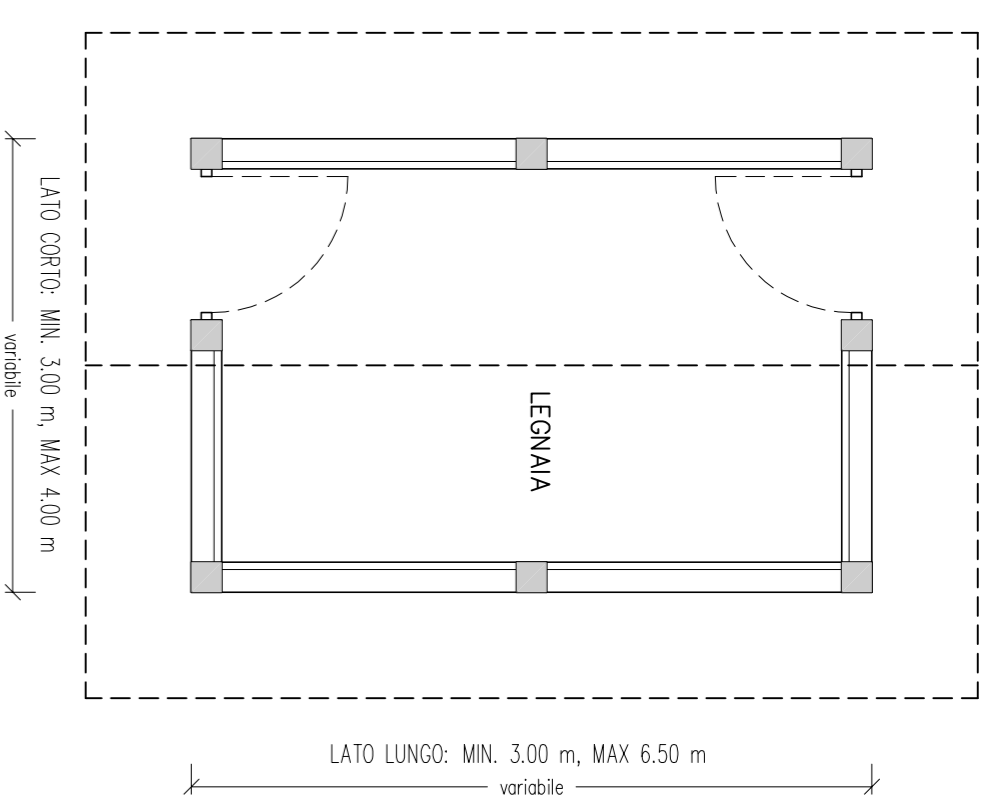

## Legnaia singola a 1 falda

### SCHEMA TIPO Scala 1:50

Da realizzare in aderenza a edifici o muraure

NOTA BENE: VALE COMUNQUE  
IL LIMITE DI 60 MC STABILITO  
DALLE NORME DI ATTUAZIONE

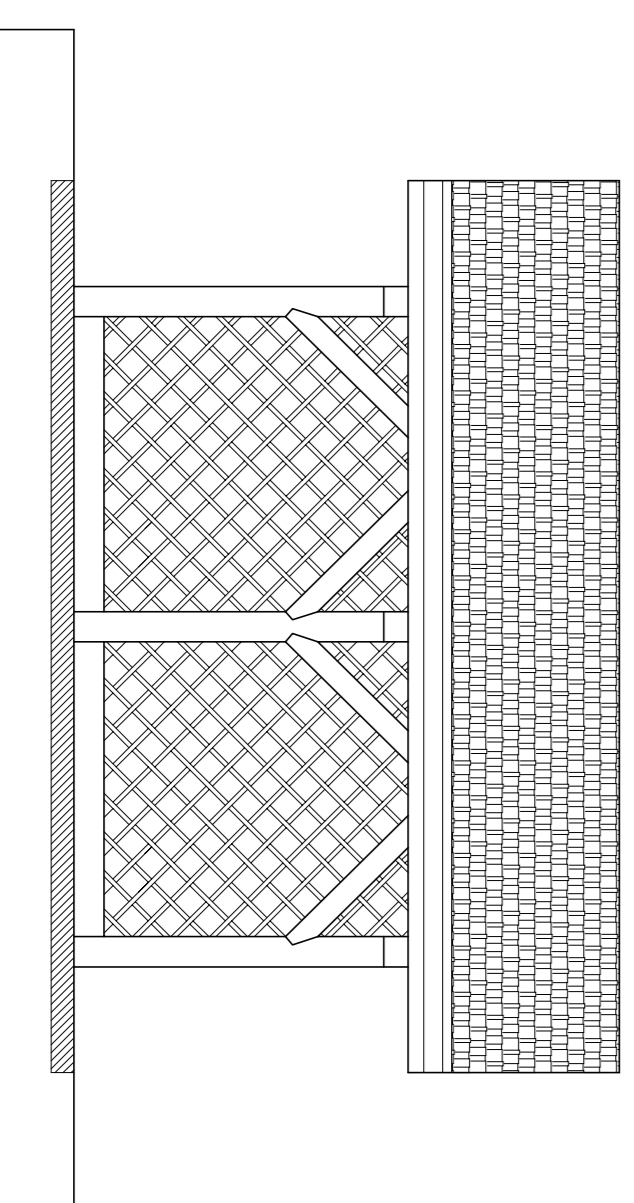
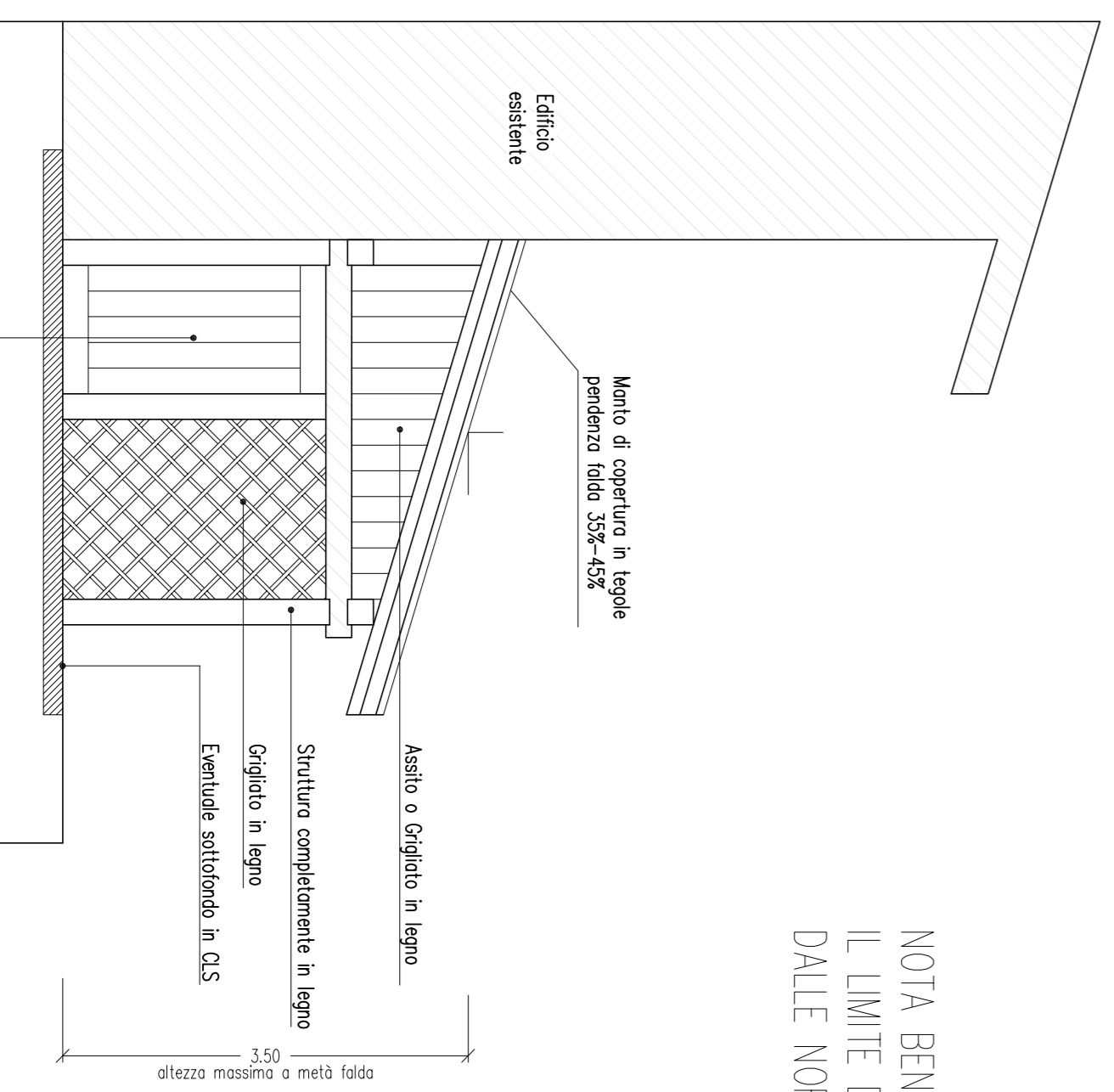
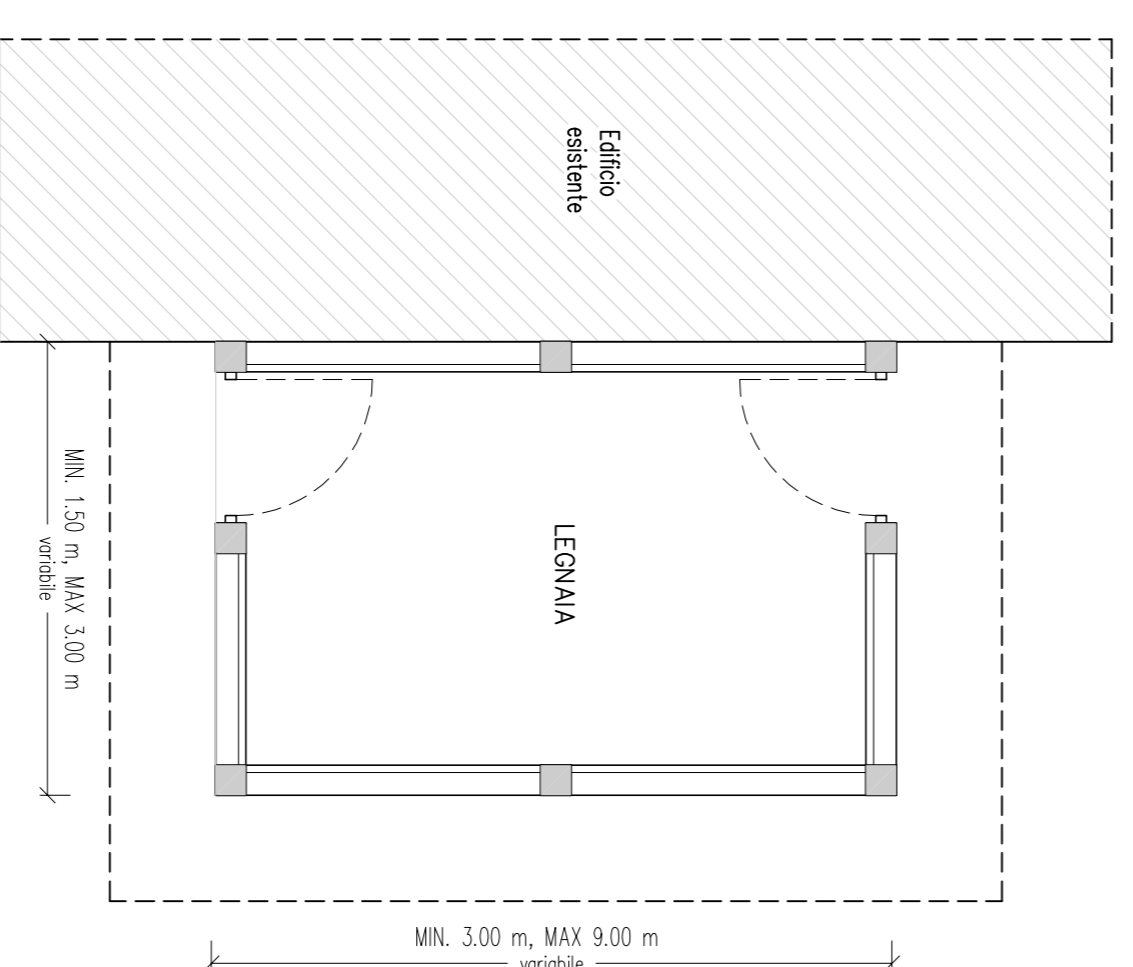

Comune di Ruffrè - Mendola

Provincia di Trento

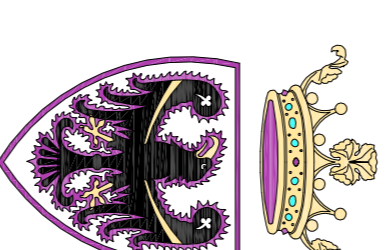
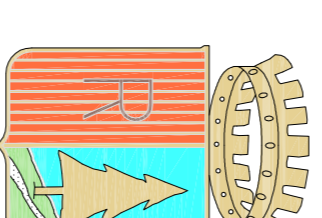

## PIANO REGOLATORE GENERALE

### VARIANTE 2019

#### MANUFATTI ACCESSORI

 <p>Ing. Roberto Battocchelli Geom. Roberto Menghini Via Roma n.55 38011 CAVALARENDO (TN) tel. 0463/839015 fax. 0463/839881 e-mail: studio2r@snel.it</p>	DATA	APRILE 2019
	SCALE	
ALLEGATO		
	7	
		IL TECNICO